

Not-A-Bottle™ Container System – An Environmentally Superior Package

Introductory Presentation

Charles W. Schroeder
Inventor and Manager
Rocky Mountain Patents, LLC
www.RockyBusiness.com

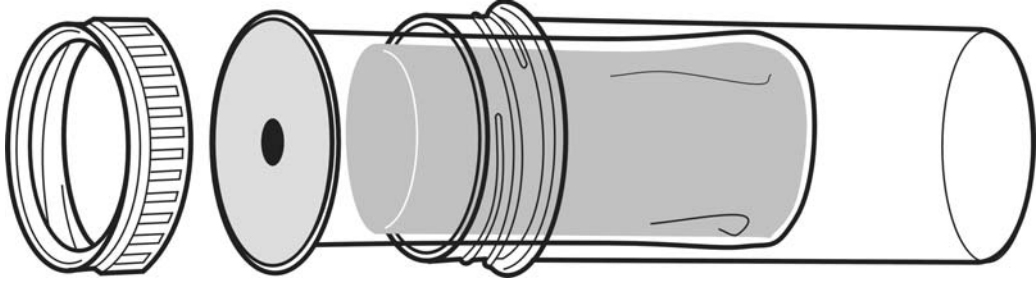

Rocky Mountain Patents, LLC
259 Solomon Dr., Estes Park, CO 80517-7255

(970) 577-9917

www.RockyBusiness.com
CWS@RockyBusiness.com

Table of Contents

- Description and Illustrations
- Applications
- Commercial Benefits
- Strategic Fit
- Significant Savings Possible
- Intellectual Property
- Licensing Opportunities

Description and Illustrations

The Not-A-Bottle™ container system consists of:

- Lightweight, flexible plastic bags
 - Contain flowable material
 - Have a lip (much like a baby bottle liner)
 - Have pierce-able top or pull tab for opening
- Separate dispensing container to hold the flexible bags
- Cap for the container
 - Captures bag lip between the container and cap
 - Has dispenser attached appropriate for the material
- System allows instant refill (and disposal) of ONLY the bag and desired flowable material

Components and Fit

CAP



BAG

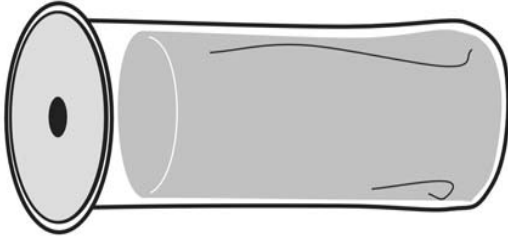

HOLDER

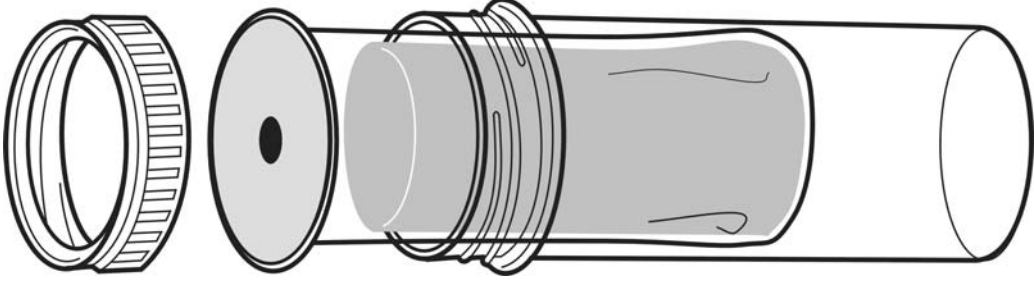
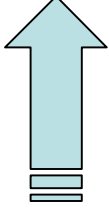
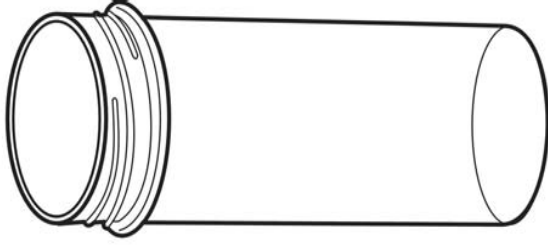

Examples of Caps

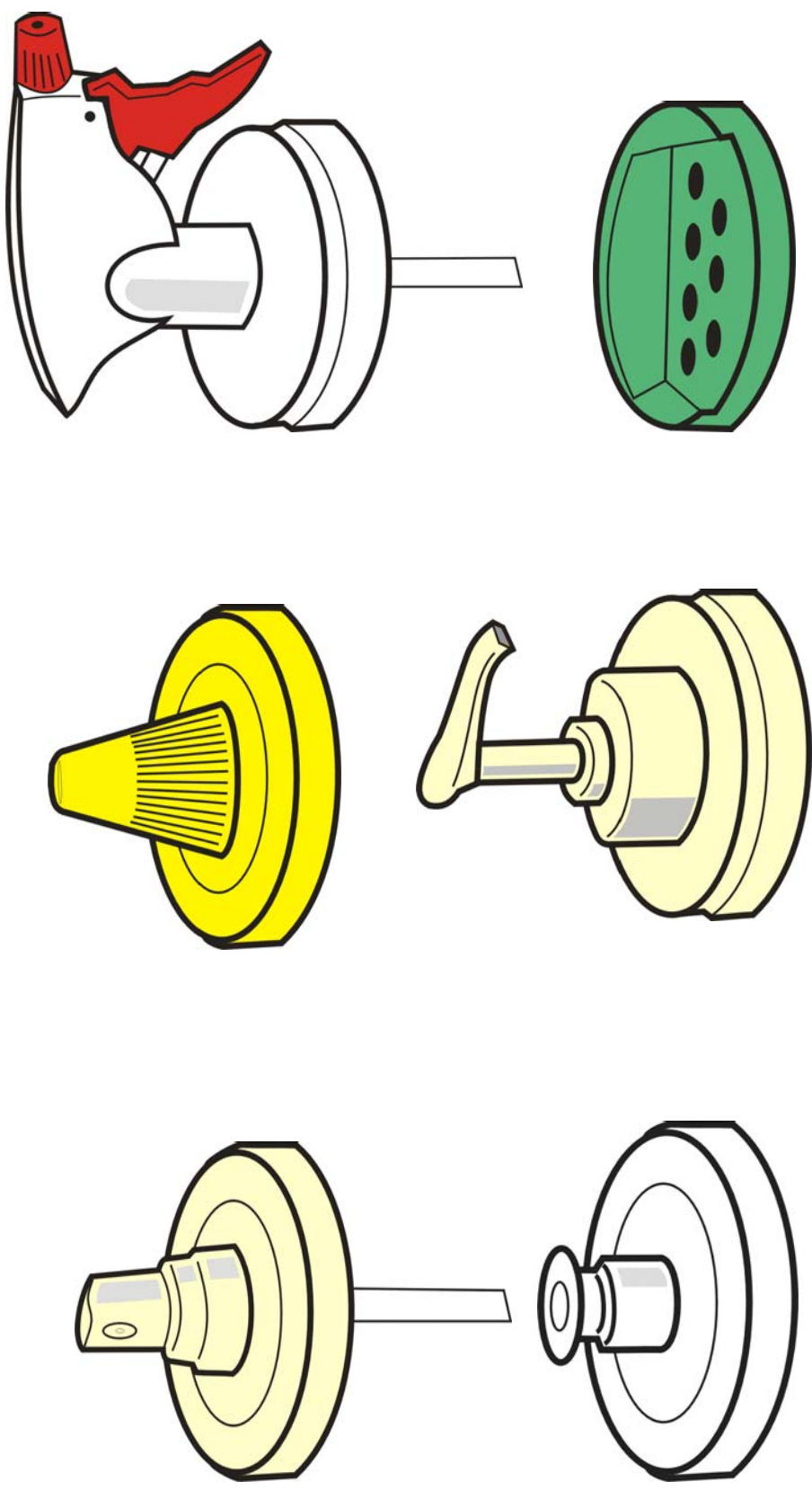

Configured for Drinking Tube Applications

TOP – WITH DRINKING TUBE

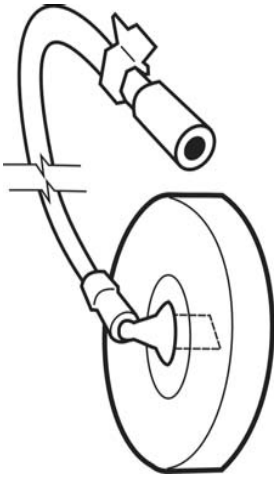

BEVERAGE BAG

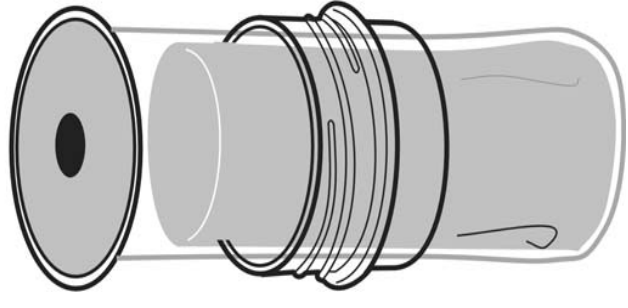

**SHORTENED HOLDER BODY
FOR BACKPACK USE**



Motor Oil Cap

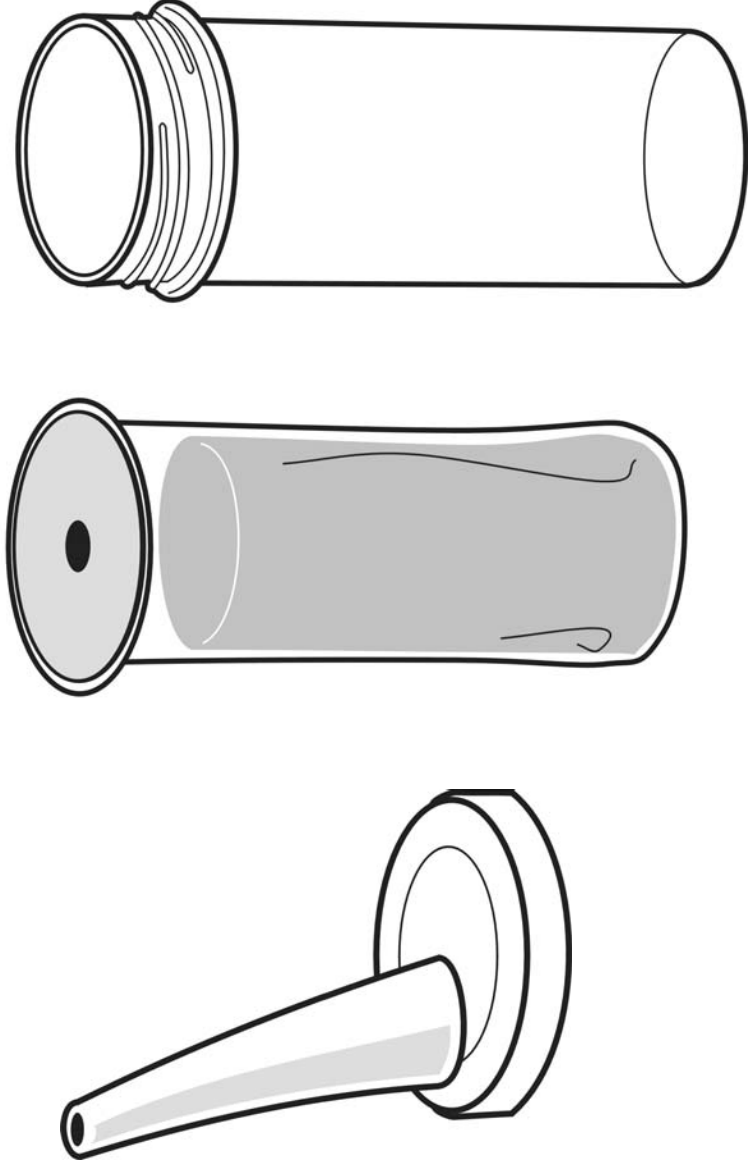

Use of Not-A-Bottle™ Container System for Dispensing Motor Oil

Examples of Bag Openings

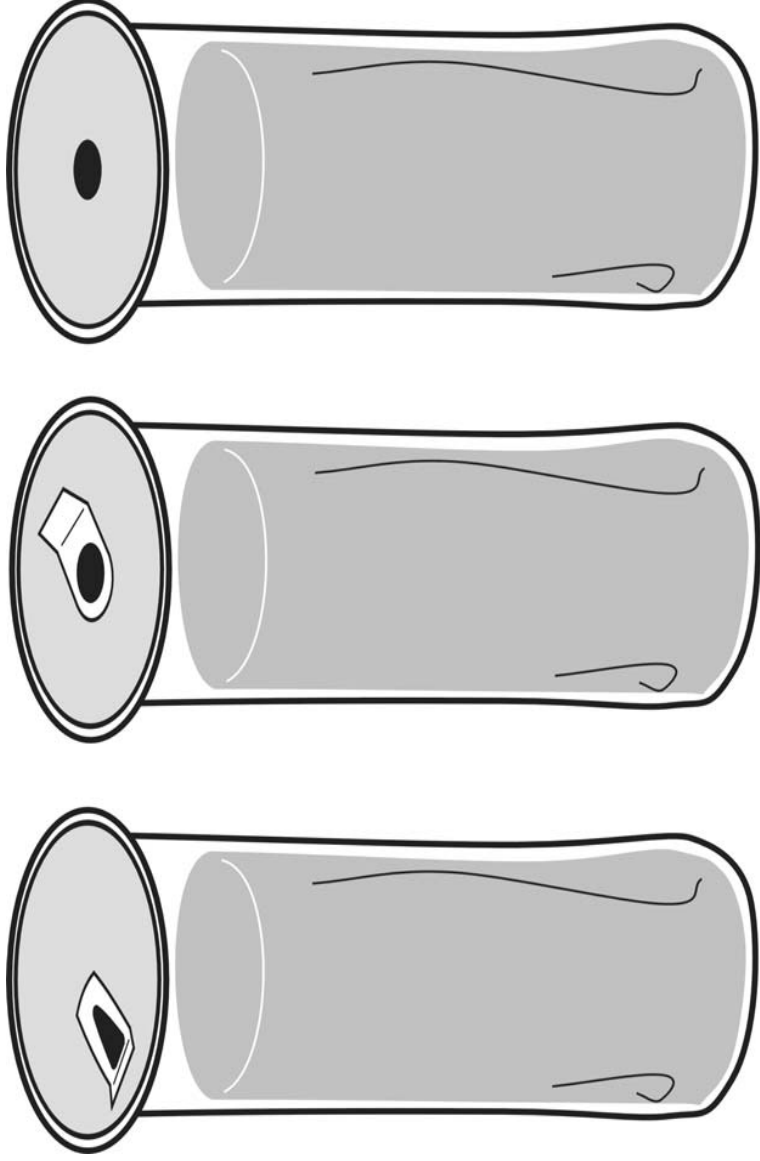

Applications

Potential applications include:

- Household Products, including soaps, detergents, and spray on cleaners
- Personal Products, including shampoos, lotions, and hair spray
- Beverages, including tea, water, juice, and power drinks
- Alcoholic Beverages
- Dairy, including milk and soy
- Baby Formula
- Foods, such as condiments and salad dressing
- Motor Oil and Lubricants
- Pharmaceuticals

In each case, a dispensing container specific to the application allows instant refill by simply replacing the product bag.

Commercial Benefits

- Reduced cost
 - Significantly less plastic than bottles
 - No expensive closures
 - No bottle deposits
 - Dispensers can be re-used time and again
- Environmentally superior package
 - Decreased plastic use
 - Minimal landfill if not recycled
- Centers on Strategic Growth Channel of warehouse and large volume retailers
 - Multi-pack applications

Strategic Fit

The **Not-A-Bottle™** container system provides reusable containers with inserted product bags:

- Provides easy, instant refills
- Reduces plastic use (**source reduction**) compared to plastic bottles
- Reduces landfill space if not recycled

The **Not-A-Bottle™** container system provides differentiation from competition:

- Implements visible and tangible steps toward environmental protection
- Provides basis for an environmentally oriented advertising campaign
- Allows consumers to take steps to reduce their impact on the environment

Strategic Fit (Continued)

In a world where product differentiation becomes more difficult, the **Not-A-Bottle™** container system also provides:

- Barrier to entry = Patent License
- Sustainable Competitive Advantage = Patent License

Significant Savings Possible

- **Expected plastic savings** of product bag vs. current packaging is expected to be in the range of **75% to 95%**
 - Savings from container vs. bag
 - Many additional refills without replacement of expensive sprayers, pumps, etc.
- Of course, the customer’s “first” product use will require a reusable holder and dispenser cap – so savings begin with the second product bag used
- With plastic resin costs alone in the **US\$ 0.50 to US\$ 0.70 per pound** range, there are indeed significant savings possible!

Intellectual Property

Rocky Mountain Patents, LLC is the owner of the Not-A-Bottle™ Container System and has intellectual property protection afforded by:

- US Patent 6,651,845
- USPTO Trademark Application Serial No. 78329475

Charles W. Schroeder is the Manager and Sole Member of Rocky Mountain Patents, LLC.

Licensing Opportunities

Rocky Mountain Patents, LLC now owns and is licensing the **Not-A-Bottle™** container system technology for use with all types of flowable materials.

Exclusive, global licenses are currently available for specific application categories. Licenses are targeted for Global 500 Corporations with a Sustainability focus.

Please contact:

Charles W. Schroeder
Inventor and Manager
Rocky Mountain Patents, LLC
www.RockyBusiness.com

Rocky Mountain Patents, LLC
259 Solomon Dr., Estes Park, CO 80517-7255

(970) 577-9917

www.RockyBusiness.com
CWS@RockyBusiness.com